



# LIVEPANEL GREEN WALL

---

OPERATION MANUAL



# TABLE OF CONTENTS

---

▶ LivePanel System Overview	3
▶ Irrigation System	6
▶ Maintenance	17
▶ Troubleshooting	18
▶ Contact Information	20

## REPRESENTATIVE LIVEPANEL LIVING GREEN WALL

## PLANT CASSETTE

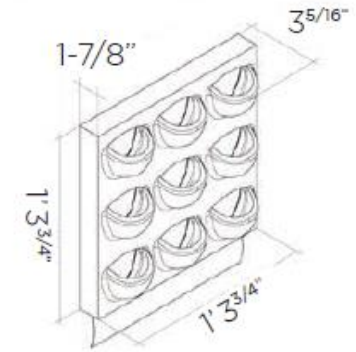
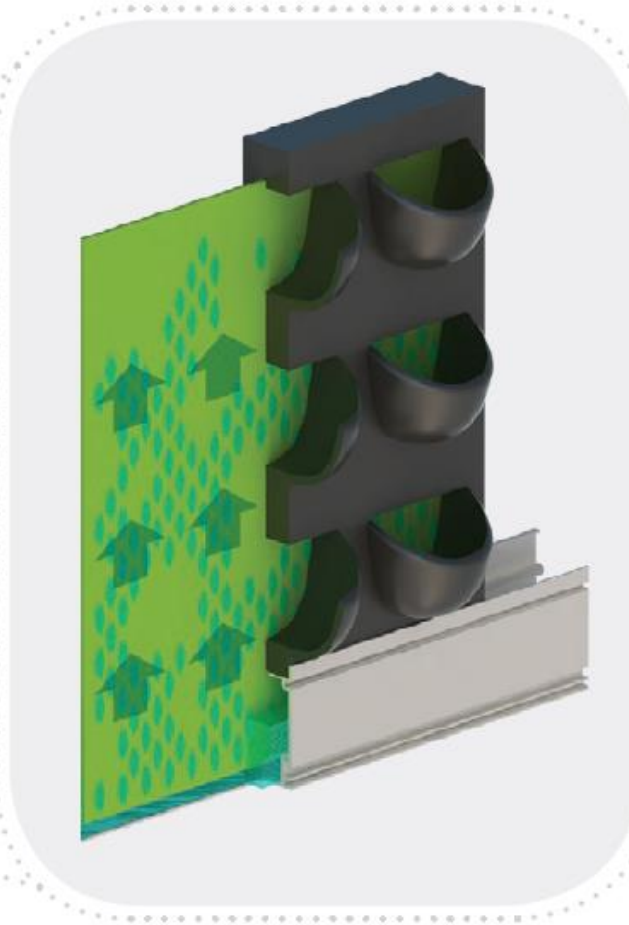
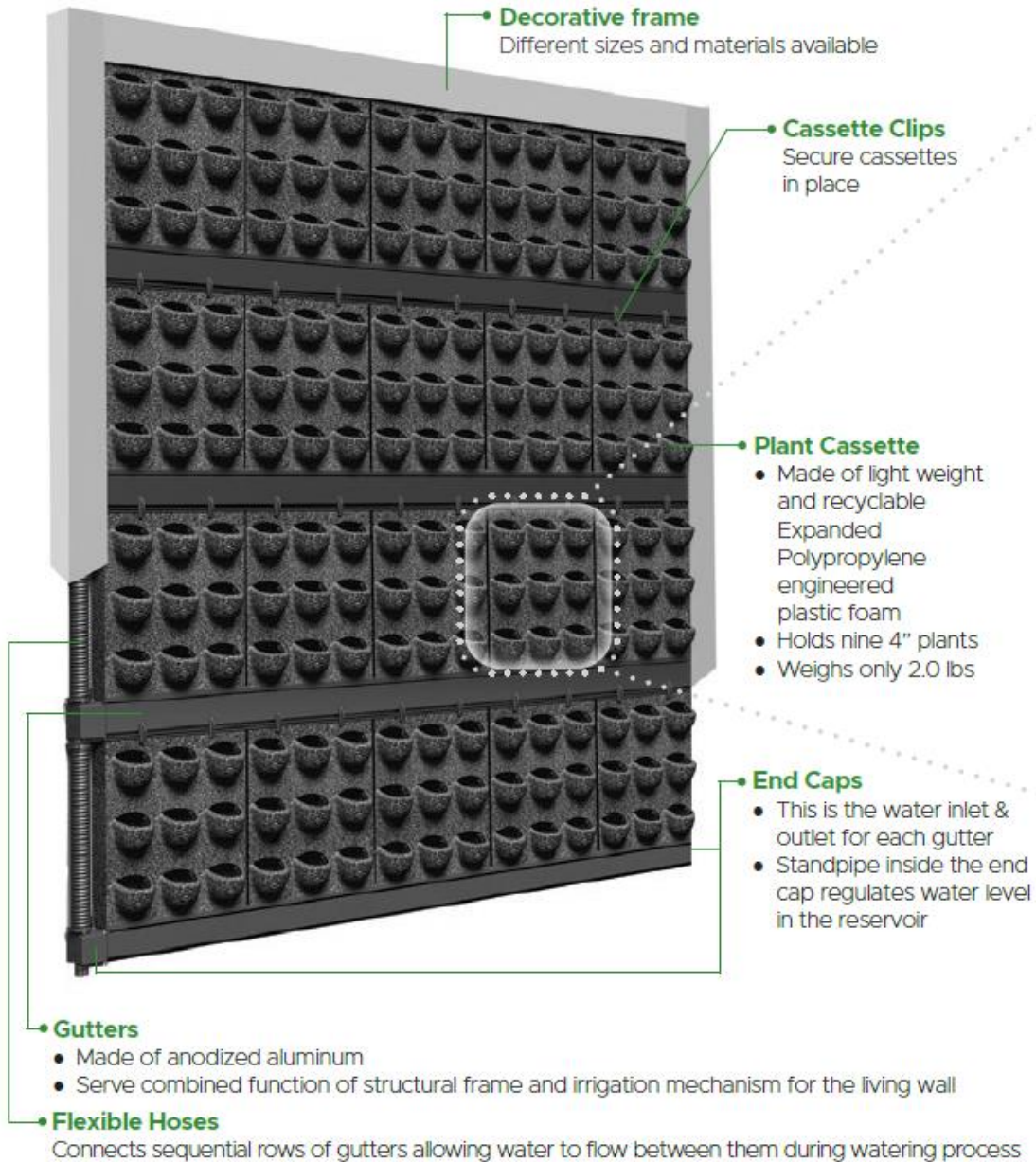

- **PLANTS THRIVE** because their roots are allowed to spread freely throughout each cassette, resulting in a lush and vibrant green wall
- **PLANTS REMAIN HEALTHY** because they sit at a natural growth angle and are supported by the individual plant cups
- **POLYESTER BLEND WICK** supplies even and steady water and the plastic back shell keeps moisture contained

# IRRIGATION SYSTEM

---

- ▶ Each LivePanel wall has its own Irrigation Control Unit (“ICU”).
- ▶ The Hunter timer inside the ICU is what controls the watering schedule.
- ▶ The emitter valve in the top gutter of each section is set to fill at a rate of 10 gallons per hour.
- ▶ The water reservoirs should always be full of water. If the bottom gutter is full then all gutters above it are also full. Adjust watering times on the Hunter Controller as needed to make sure each section is always full of water.

# MAINTENANCE

---

- ▶ The water reservoirs should always be full of water. If the bottom gutter is full then all gutters above it are also full. Make sure to check each section of the wall. Adjust watering times on the Hunter Controller as needed to make sure each section is full of water.
- ▶ Flush the system in the water every 6 months by running each zone for 6x its normal time
- ▶ Plant maintenance company should monitor the plants by the artificial lights and adjust the lighting timer if it looks like the plants are not getting enough light
- ▶ Plant maintenance company should keep plants pruned and replace any dead plants as needed

# TROUBLESHOOTING

---

## ▶ Plants and soil are too dry

- Is there water in the reservoir? If no...
  - Check reservoirs above. Do any have water or is the whole section dry?
  - Check to make sure the solenoid valve is functioning properly
  - Consider adjusting the timing on the irrigation controller to run that zone longer
  - Check other zones to make sure there aren't issues with those zones as well
- Was the wick in the reservoir?
- Are the plats getting too much light, especially direct sunlight?

## ▶ Plants and soil are too wet

- Use light meter to measure the lighting. Most likely the lighting is too low. Ideally we want the plants to get 150+ foot-candles of light for 10+ hours per day

# TROUBLESHOOTING

---

- ▶ Plants look unhealthy
  - Is there a soil borne or leaf disease/fungus/pest infestation?
  - Is the pH level in the water OK?
  - Are the plants getting fertilizer? Consider adding other nutritional supplementation
- ▶ Water is leaking
  - Has a solenoid valve failed/cracked?
  - Has the seal on one of the endcaps failed?
  - Has one of the PEX connections failed?

# CONTACT INFORMATION

---



2835-A Jeff Adams Drive  
Charlotte, NC 28206

+1 855.275.8111  
[info@suiteplants.com](mailto:info@suiteplants.com)





# X-CORE<sup>®</sup>

Residential Irrigation Controller

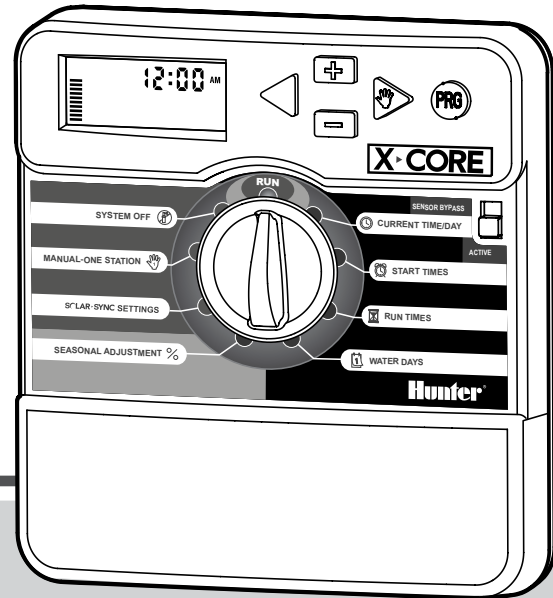

Owner's Manual and  
Programming Instructions

**Hunter<sup>®</sup>**

12:00 AM



**X-CORE**

**RUN**

SYSTEM OFF

SENSOR BYPASS

CURRENT TIME/DAY

ACTIVE

MANUAL SINGLE STATION

START TIMES

SOLAR-SYNC SETTINGS











RUN TIMES

SEASONAL ADJUSTMENT %







WATER DAYS

**Hunter**<sup>®</sup>

# TABLE OF CONTENTS

<b>X-CORE COMPONENTS</b> .....	4
<b>MOUNTING THE CONTROLLER TO WALL</b> .....	8
<b>CONNECTING VALVES AND TRANSFORMER</b> .....	9
<b>ACTIVATING THE BATTERY</b> .....	10
<b>REPLACING THE BATTERY</b> .....	10
<b>CONNECTING A MASTER VALVE</b> .....	11
<b>CONNECTING A PUMP START RELAY</b> .....	12
<b>CONNECTING A HUNTER “CLICK” WEATHER SENSOR</b> .....	13
Testing the Weather Sensor .....	13
Manually Bypassing the Weather Sensor .....	13
<b>CONNECTING A HUNTER SOLAR SYNC ET SENSOR</b> .....	14
Installing Solar Sync Sensor .....	14
Installing the Wireless Solar Sync® .....	14
Solar Sync Settings .....	14
Region  .....	15
Water Adjustment  .....	16
Uninstalling a Solar Sync Sensor .....	14
Calibration/Setup .....	17
Solar Sync Delay Feature .....	18
<b>CONNECTING A HUNTER REMOTE</b> .....	19
Connecting to a Hunter Remote (not included) .....	19
To install the SmartPort connector .....	19
<b>POWER FAILURES</b> .....	19
<b>PROGRAMMING THE CONTROLLER</b> .....	20
Setting the Date and Time  .....	21
Setting the Program Start Time(s)  .....	21
Eliminating a Program Start Time .....	21
Setting Station Run Times  .....	21
Setting Days To Water  .....	21
Selecting Specific Days of the Week to Water .....	21
Selecting Odd or Even Days to Water .....	22
Selecting Interval Watering  .....	22
Setting Event Day(s) Off .....	22
Automatic Watering  .....	22
System Off  .....	22
Programmable Rain Off .....	23
Seasonal Adjustment % .....	23
Manually Run a Single Station  .....	23
One-Touch Manual Start and Advance .....	24
<b>ADVANCED FEATURES</b> .....	25
Programmable Sensor Override .....	25
Test Program of All Stations .....	25
Hunter Quick Check® Diagnostics .....	25
Easy Retrieve™ Program Memory .....	26
Programmable Delay Between Stations .....	26
Resetting Controller / Clearing Controllers Memory .....	26
Click Delay Instructions .....	27
<b>TROUBLESHOOTING GUIDE</b> .....	30
<b>SPECIFICATIONS</b> .....	33
Operating Specifications .....	33
Electrical Specifications .....	33
Explanation of Symbols .....	33
<b>CERTIFICATE OF CONFORMITY TO EUROPEAN DIRECTIVES</b> .....	34

# X-CORE COMPONENTS

A LCD Display		
1	 <b>Run Times</b>	Allows user to set each valve station run time from 1 minute to 4 hours
2	 <b>Start Times</b>	Allows 1 to 4 start times to be set in each program
3	<b>Station Number</b>	Indicates currently selected station number
4	<b>Program Designator</b>	Identifies program (A, B, or C) in use
5	<b>Day of the Week</b>	Identifies day of the week
6	<b>Interval Watering</b>	Identifies month when programming current date
7	<b>Odd/Even Watering</b>	Identifies if Odd or Even watering has been selected
8	<b>Flashing Sprinkler</b>	Indicates that watering is taking place
9	 <b>System Off</b>	Allows user to discontinue all programs and watering. Also allows the user to set the programmable “rain off,” which stops watering for a period from 1 to 7 days.
10	 <b>Umbrella</b>	Indicates that the rain sensor is active
11	<b>% Seasonal Adjustment</b>	Allows the user to make run time changes according to the seasons without reprogramming the controller. Bars on the left allow quick visual reference to the seasonal adjustment percentage. When using Solar Sync ET Sensor, will display seasonal adjust updated daily by sensor.
12	 <b>Rain Drop</b>	Indicates watering will occur on the selected day
13	 <b>Crossed Rain Drop</b>	Indicates the watering will NOT occur on the selected day
14	 <b>Calendar</b>	Indicates interval watering schedule has been programmed. Icon also appears when programming the current day

# X-CORE COMPONENTS

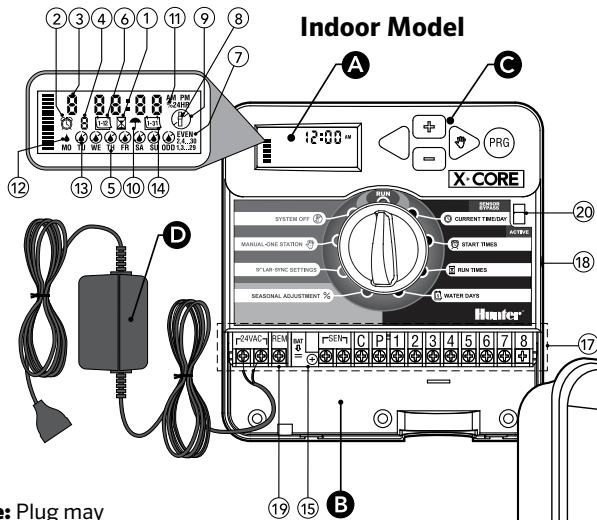



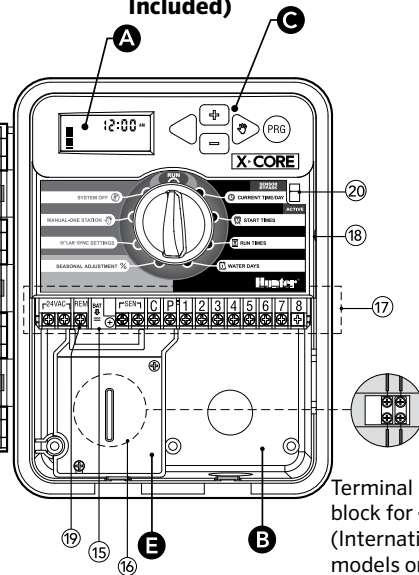

**Note:** Plug may look different from illustration

## Outdoor Model (Internal Transformer Included)









Terminal block for **-E** (International models only)

# X-CORE COMPONENTS

<b>B Wiring Compartment</b>		
<b>15</b>	<b>Lithium Battery</b>	The replaceable lithium battery (included) allows the controller to be programmed in the absence of AC power. In addition, the battery will provide power for backup timekeeping in the event of a power outage.
<b>16</b>	<b>Internal Junction Box</b>	Junction box in outdoor models for making AC power connections
<b>17</b>	<b>Terminal Strip</b>	Use to attach transformer, sensor, and valve wires from their source to the controller
<b>18</b>	<b>Reset Button</b>	Use to reset the controller (located on right side of controller)
<b>19</b>	<b>REM</b>	Allows for connection of Hunter SmartPort® and Hunter Remote Controls
<b>20</b>	<b>Sensor Bypass Switch</b>	Ignores “Clik” weather sensor input when in Bypass position
<b>C Control Buttons</b>		
	 Button	Increases the selected item flashing in the display
	 Button	Decreases the selected item flashing in the display
	 Button	Returns selected flashing display to previous item
	 Button	Advances the selected flashing display to the next item
	 Button	Selects program A, B, or C for different watering zone requirements

## X-CORE COMPONENTS

<b>Dial Settings</b>		
	<b>Run</b>	Normal dial position for all controller automatic and manual operation
	 <b>Current Time/Day</b>	Allows current day and clock time to be set
	 <b>Start Times</b>	Allows 1 to 4 start times to be set in each program
	 <b>Run Times</b>	Allows user to set each valve station run time from 1 minute to 4 hours
	 <b>Water Days</b>	Allows the user to select interval days to water
	<b>% Seasonal Adjustment</b>	Allows user to make run time changes according to the seasons without reprogramming the controller. Bars on the left allow quick visual reference to the seasonal adjustment percentage.
	 <b>Manual-One Station</b>	Allows user to activate a one-time watering of a single valve
	 <b>System Off</b>	Allows user to discontinue all programs and watering. Also allows the user to set the programmable “rain off,” which stops watering for a period from 1 to 7 days
	<b>SOLAR SYNC® Settings</b>	Allows user to program settings when using Solar Sync ET Sensor
<b>D External Transformer (Indoor Model Only)</b>		
		A plug in transformer is provided to supply AC power to the controller

## MOUNTING THE CONTROLLER TO WALL



**Note:** The indoor version of the X-Core is not waterproof or weather-resistant, and must be installed indoors or in a protected area.

1. Secure one screw into the wall. Install screw anchors if attaching to drywall or masonry wall.
2. Slide the keyhole on top of the controller over the screw.
3. Secure the controller in place by installing screws in the holes below the terminal strip.



**NOTE:** Do not plug transformer into power source until controller is mounted and all valve wiring has been connected.



**NOTE:** For XC - x01 - A: If the supply cord is damaged, it must be replaced by the manufacturer or service agent, or a similarly qualified person in order to avoid hazard.



**NOTE:** The door on outdoor units must remain closed for maximum water resistance.

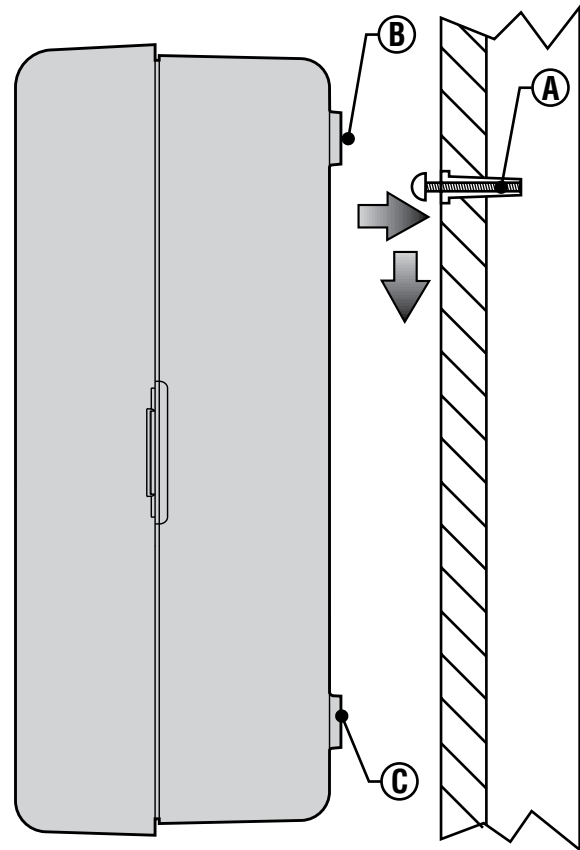



# CONNECTING VALVES AND TRANSFORMER

Installation of the X-Core should only be done by trained personnel.

1. Route valve wires between the control valve location and controller.
2. At valves, attach a common wire to either solenoid wire on all valves. This is most commonly a white colored wire. Attach a separate control wire to the remaining wire of each valve. All wire connections should be done using waterproof connectors.
3. Route the valve wires through the conduit. Attach the conduit through the bottom right side of the controller.
4. Secure the white valve common wire to the C (Common) screw on the terminal strip. Attach each of the individual valve control wires to the appropriate station terminals and tighten their screws.
5. Indoor Models: route the transformer cable through the hole on the left side of the controller and connect the wires to the two screws marked 24 VAC.

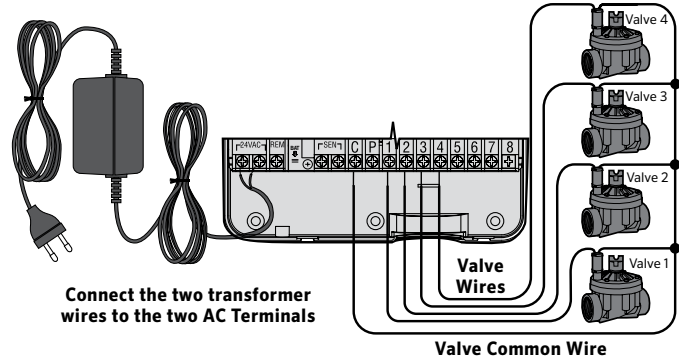

**NOTE:** The indoor transformer cable should not be cut. If the cable is cut, the red and white wires in the cable must be joined together, or the controller will not work.

Outdoor Models: transformer wires are already connected to the AC terminals so all that is required is to connect primary power to the junction box (see below).



**NOTE:** X-Core outdoor models are water and weather-resistant throughout document. Connecting the outdoor X-Core to primary AC power should only be done by a licensed electrician following all local codes. Improper installation could result in shock or fire hazard.

## **E** High Voltage Wiring (Outdoor Model only)

1. Route AC power cable and conduit through the ½" (13 mm) conduit opening on the left side bottom of the cabinet.
2. Connect one wire to each of the two wires inside the junction box. The ground wire should be connected to the green wire. Wire nuts are provided to make these connections.

**Note: For -E models only:** Connect the wires to the AC terminal block inside the junction box. AC supply wires must be 14 AWG (1.85 mm) or larger with appropriate circuit breaker for the wire size. A switch or circuit-breaker shall be included in the building installation (in close proximity to the controller, within easy reach of the operator) and marked as the disconnecting device for the equipment.

3. Replace the junction box cover.

## ACTIVATING THE BATTERY

After installing your X-Core, make sure to remove the battery contact insulator to allow the X-Core to keep time in the event of a power outage.

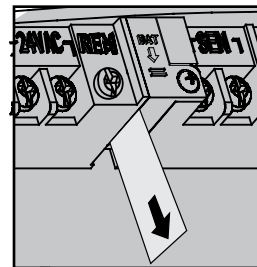

**CAUTION:**  
Risk of explosion if battery is replaced by an incorrect type. Dispose of used batteries according to the instructions.

## REPLACING THE BATTERY

A high-energy lithium battery is included with your X-Core controller. The battery allows the user to remotely program the controller without connecting AC power. It is also used to keep the current time and day during power outage conditions.

To replace the battery:

1. Remove the screw from the battery holder.
2. Slide the battery holder down to access the battery.
3. Remove and replace the new battery into the battery holder and reinstall the battery holder.

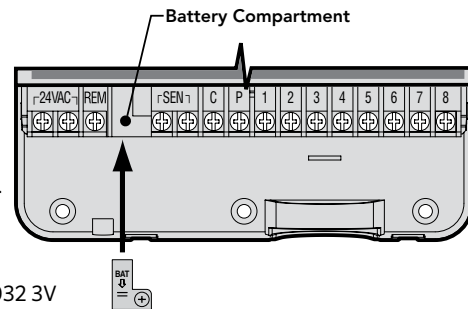
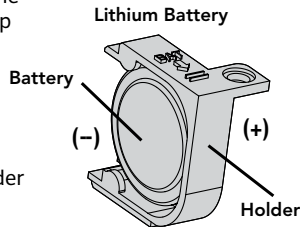

Battery type: CR2032 3V



**NOTE:** This positive(+) side of the battery should face the inside of the battery holder.

## CONNECTING A MASTER VALVE



**NOTE:** Complete this section only if you have a master valve installed in your irrigation system. A master valve is a “normally closed” valve installed at the supply point of the main line that opens only when the controller initiates a watering program.

1. At the Master Valve, attach the common wire to either solenoid wire of the valve. Attach a separate control wire to the remaining solenoid wire.
2. The common wire should be attached to the **C** terminal inside the controller. The other wire coming from the master valve should be attached to the **P** terminal inside the controller. Tighten each terminal screw.

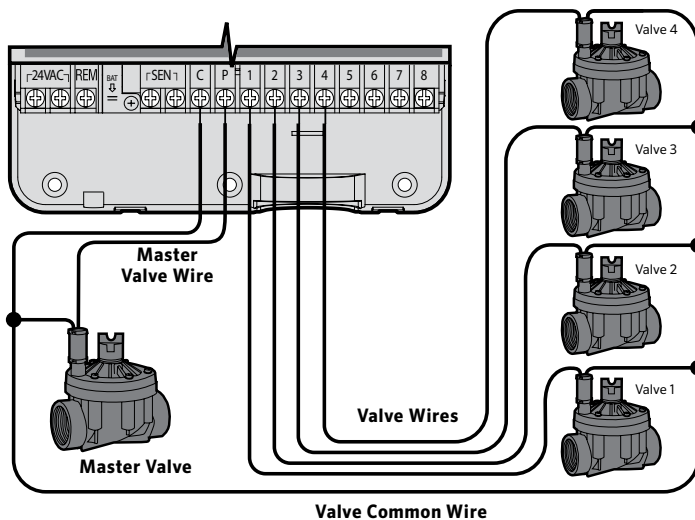

## CONNECTING A PUMP START RELAY



**NOTE:** Complete this section only if you have a pump start relay installed. A pump start relay is a device that uses a signal from the controller to actuate a separate electrical circuit to energize a pump to provide water to your system.

The controller should be mounted at least a 15 ft (4.5 m) away from both the pump start relay and pump to minimize any potential electrical interference.

1. Route a pair of wires from the pump relay into the controller.
2. Connect a common wire to the **C** (common - typically a white wire) terminal inside the controller and connect the remaining wire from the pump start relay to the **P** (Pump) terminal.

Relay holding current draw must not exceed 0.3 A. Do not connect the controller directly to the pump or damage to the controller will result.

<http://www.hunterindustries.com/support/controllers/pump-start-relay>

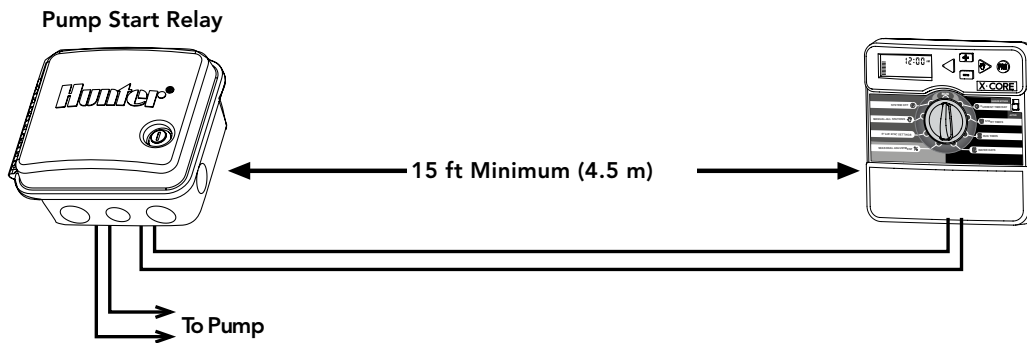

# CONNECTING A HUNTER “CLIK” WEATHER SENSOR

A Hunter weather sensor or other micro-switch type weather sensors can be connected to the X-Core. The purpose of this sensor is to stop automatic watering when weather conditions dictate.

1. **Remove the metal jumper** plate that is attached across the two SEN terminals inside the controller.
2. Connect one wire to one SEN terminal and the other wire to the other SEN terminal.

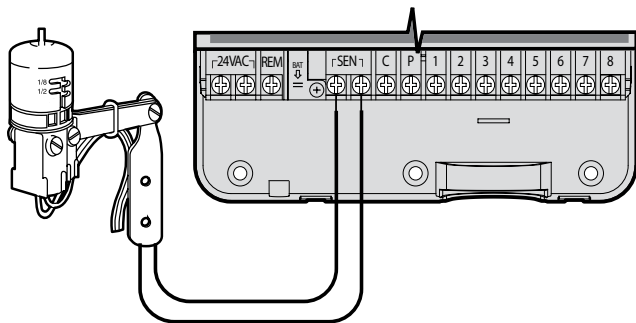

When the weather sensor has deactivated automatic watering, the OFF, and ☂ icon will appear on the display.

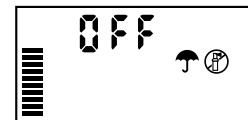

## Testing the Weather Sensor

The X-Core provides simplified testing of a rain sensor when the sensor is wired into the sensor circuit. You can manually test proper operation of the rain sensor by running an **AUTO CYCLE** or by activating the system using the **One Touch AUTO CYCLE** (See page 22). During the Manual cycle, pressing the top spindle on the Hunter sensor will interrupt watering.

## Manually Bypassing the Weather Sensor

If the rain sensor is interrupting irrigation, you can bypass it by using the bypass switch on the front of the controller. Slide the switch to the **SENSOR BYPASS** position to disable the rain sensor from the system to allow for controller operation. When using the **MANUAL - ONE STATION** function, the controller will automatically bypass sensor inputs for the selected time. Once complete, the controller will default to selected settings.



**NOTE:** Enabling the Sensor Bypass switch has no effect on the seasonal adjust updates from the Solar Sync sensor. It will, however, bypass the Rain Klik and Freeze - Klik functionality of the sensor.

# CONNECTING A HUNTER SOLAR SYNC ET SENSOR

The X-Core is compatible with the Solar Sync and Wireless Solar Sync systems. Solar Sync is a sensor system that will automatically adjust the X-Core controller's watering schedule (based on changes in local climate condition) by using the Seasonal Adjust function. The Solar Sync uses a solar and temperature sensor to determine evapotranspiration (ET), or the rate at which plants and turf use water, and also includes Hunter Rain Klik and Freeze Klik technology that will shut down irrigation when it rains and/or during freezing conditions.



**NOTE: Solar Sync will apply a default seasonal adjust value of 100% until the first full day (24 - hour period) of weather measurements have been received from the sensor.**



**NOTE: Enabling the Sensor Bypass switch has no effect on the seasonal adjust updates from the Solar Sync sensor. It will, however, bypass the Rain Klik and Freeze Klik functionality of the sensor.**



**NOTE: The Solar Sync module is not required for installation using the X-core Controller.**

## Installing Solar Sync Sensor

Connect the Green and Black wire from the Solar Sync Sensor to the "SEN" wiring terminals on the X-Core controller, similar to picture on page 11. It does not matter which wire connects to which terminal. Turn the dial to the "Solar Sync Settings" position. The display will initially show dashed lines and then will show the default Region setting (3) on the left



and the default Water Adjustment setting (5) on the right. Adjust the Region as needed by using the ▲ and ▼ buttons (refer to page 13 for explanation of Solar Sync Region setting). Use the ► button to advance to the right to adjust the Water Adjust setting as needed (see page 14 for explanation of Water Adjust setting).

## Installing the Wireless Solar Sync

Connect the Green and Black wire from the Wireless Solar Sync Receiver to the "SEN" wiring terminals on the X-Core controller. It does not matter which wire connects to which terminal. Turn the dial to the "Solar Sync Settings" position. The display will initially show dashed lines and then will show the default Region setting (3) on the left and the default Water Adjustment setting (5) on the right. Adjust the region as needed by using the ▲ and ▼ buttons (refer to page 13 for explanation of Solar Sync Region setting). Use the ► button to advance to the right to adjust the Water Adjust setting as needed (see page 14 for explanation of Water Adjust setting).



## Solar Sync Settings

Once the Solar Sync sensor is connected to the X-Core controller, two numbers will appear in the display when the dial is turned to the Solar Sync Settings position. The number on the left of the screen is the Region setting, and the number on the right on the screen is the Water Adjustment setting (as shown above).

# CONNECTING A HUNTER SOLAR SYNC ET SENSOR

## Region

For accurate Solar Sync measurements, the controller needs to be programmed for the average peak season ET for your region. Use the table below to determine your region.

The table will assist you in identifying the type of region you live in. There are four basic ET regions, each with descriptions of the region, along with typical ET and temperature characteristics. It is recommended that, if possible, the region be chosen based upon average July ET or peak summer ET (inches/mm per day).

Use the following table for choosing your region (reference below). You can use methods **A**, **B** or **C** to help you choose which region is best for your area:

**A:** Based upon the ET of your region using the **average** July ET or peak summer ET (inches/mm per day). This is the preferred option when selecting your region.

**B:** Based upon the temperature for your region using the **average** July or the driest month high temperature (not the highest temperature for July).

**C:** Based upon the general description of your region.

IF ANY OF THE CHOICES IN THE ROWS APPLY TO YOUR SITUATION, THEN THAT IS YOUR REGION SETTING CHOICE.			
	A	B	C
Region <b>1</b>	If the average July ET is <b>&lt; 0.17" (4.3 mm) per day</b>	If the average temperature for July is <b>65°–75° (18°C – 24°C)</b>	<ul style="list-style-type: none"> <li>• <b>U.S. Northern States</b></li> <li>• <b>Coastal Regions</b></li> </ul>
Region <b>2</b>	If the average July ET is <b>0.18" – 0.23" (4.6 mm – 5.8 mm) per day</b>	If the average temperature for July is <b>75°– 85° (24°C – 29°C)</b>	<ul style="list-style-type: none"> <li>• <b>Mountains</b></li> <li>• <b>U.S. Northern Inland States</b></li> </ul>
Region <b>3</b>	If the average July ET is <b>0.24" – 0.29" (6.1 mm – 7.4 mm) per day</b>	If the average temperature for July is <b>85° – 95° (29°C – 35°C)</b>	<ul style="list-style-type: none"> <li>• <b>U.S. Southern States</b></li> <li>• <b>Inland/High Desert</b></li> </ul>
Region <b>4</b>	If the average July ET is <b>&gt; 0.30" (7.6 mm) per day</b>	If the average temperature for July is <b>95° – 105° (35°C – 41°C)</b>	<ul style="list-style-type: none"> <li>• <b>Deserts</b></li> </ul>

\* For Southern hemisphere locations, use the month of January.

## CONNECTING A HUNTER SOLAR SYNC ET SENSOR

---

### Water Adjustment $\updownarrow$ †



The Water Adjustment is a 1 to 10 scale that allows for easy adjustment of the Seasonal Adjust value from the Solar Sync ET Sensor. Upon installation of the Solar Sync ET Sensor, it is recommended that the Water Adjustment setting stay at the default value of 5. However, after installation, if you find that the seasonal adjust value is lower or higher than expected, the Water Adjustment value can be modified to modify the Seasonal Adjust output value. See Calibration/Setup on page 15 for explanation of how to use Water Adjustment scale to fine - tune seasonal adjust output value.



**NOTE: If an individual zone is “wetter” or “drier” than the rest of the system, simply increase or decrease the amount of run time on the controller.**

### Uninstalling a Solar Sync Sensor

If a Solar Sync sensor has been installed on the X-Core controller, then the seasonal adjust value used by the controller will be calculated from the weather data supplied by the Solar Sync sensor. If it is decided that the Solar Sync sensor will no longer be used with the X-Core controller, it must be uninstalled. **If the Solar Sync sensor is not uninstalled, the controller will not allow the seasonal adjust value to be manually changed.** For example, if the seasonal adjust value shown on the controller was 50% when the Solar Sync sensor was removed, it will remain 50% until the Solar Sync sensor is uninstalled.

To uninstall the Solar Sync sensor, simply disconnect the green and black wires from the controller terminal and then turn the dial to the “Solar Sync Settings” position. The display should show dashes, indicating that the controller no longer recognizes the Solar Sync sensor for calculation of seasonal adjustment. Now the seasonal adjust value can be changed manually by turning the knob to the “Seasonal Adjust” position and using the  or  button to adjust the value.



# CONNECTING A HUNTER SOLAR SYNC ET SENSOR

---

## Calibration/Setup

After Solar Sync has been installed and programmed, it is recommended to allow the system to run for a few days at the initial setting. Because of the variety in site conditions (including sensor location, amount of direct sunlight available to the sensor, reflective heat from surrounding structures, etc), **the initial setting may require adjustment in order to arrive at the desired performance.** The calibration of the Solar Sync to a particular site can easily be accomplished by adjusting the Region and/or Water Adjustment settings. The instructions below outline this process:

1. Install Solar Sync sensor
2. Program Region and allow system to operate at initial setting for a minimum of 3 days (see page 13 for instructions on how to determine proper Region setting).
3. Observe the Seasonal Adjust on the controller. If the Seasonal Adjust amount appears to be lower or higher than expected for that time of year, the Solar Sync settings need to be adjusted.
  - a. Seasonal Adjust too low:** Turn the dial to the Solar Sync settings position. Increase the value on the Water Adjustment scale (10 is max). Once the setting is changed, the controller will immediately be updated with the new Seasonal Adjust %. Increase the Water Adjustment setting until the desired Seasonal Adjust % is shown. **If you max out the Water Adjustment scale at 10 and still require more Seasonal Adjust, move down to the next lower Region (from Region 4 to 3, for example).**
  - b. Seasonal Adjust too high:** Turn the dial to the Solar Sync settings position. Decrease the value on the Water Adjustment scale (default setting is 5). Once the setting is changed, the controller will immediately be updated with the new Seasonal Adjust %. Decrease the Water Adjustment setting until the desired Seasonal Adjust % is shown. **If you minimize the Water Adjustment scale down to 1 and still require a reduction in Seasonal Adjust, move up to the next Region (from Region 2 to 3, for example).**

**Station Run Times:** It is important to understand that Solar Sync provides a global seasonal adjustment to the controller. This means that all station run times will be modified by the seasonal adjust percentage shown. When programming the controller, the run times should be entered that represent peak season watering schedules. If the Solar Sync is adjusting to the appropriate seasonal adjust value but the run time for a particular station appears to be too long/short, adjust the station run time in the controller program.

# SOLAR SYNC DELAY FEATURE

---

## Solar Sync Delay for X-CORE®

The delay feature is accessible only after the installation of the Solar Sync. The Solar Sync Delay feature allows the user to postpone seasonal adjustment changes from being made by Solar Sync for up to 99 days.

While the Solar Sync Delay is active, the Solar Sync will continue to collect and store data.

### Operation:

To access the Solar Sync Delay setting:

1. Place the dial in the RUN position; press and hold the **+** button, rotate the dial to the Solar Sync position then release the **+** button. The following screen will be presented: **d:XX** (where **d** indicates days and **XX** indicates the number of days to be delayed).
2. Press the **+** or **-** button to increase/decrease the number of days the delay should run. Once the desired number of days is displayed, move the dial back to the RUN position to activate the delay.

To change the existing Delay days setting:

1. Open the Solar Sync Delay menu by pressing the **+** button and rotating the dial to Solar Sync Settings and release the **+** button.
2. Use the + or - keys to modify the number of days until desired numbers of delay days is displayed. (Setting the days to 00 turns Solar Sync Delay to **OFF**.)
3. Return the dial to the **RUN** position for the changes to take effect.

While Solar Sync Delay is active, the Solar Sync will continue to gather weather information and calculate the Seasonal Adjust Value. The updated seasonal adjust will be applied once the Solar Sync Delay days reach 00.



**NOTE:** The number of days remaining will not be displayed on the RUN screen. To check if the Delay feature is active, open the Solar Sync Delay menu and check the days displayed. If 1 or more days are displayed, then Solar Sync Delay is active, if 00 is displayed, then Solar Sync Delay is not active.

# CONNECTING A HUNTER REMOTE

## Connecting to a Hunter Remote (not included)

The X-Core Controller is compatible with Hunter Remote Controls (not included). The SmartPort® wiring harness (included with all Hunter Remotes) allows for fast and easy use of the Hunter controls. The Hunter remotes make it possible for you to operate the system without having to walk back and forth to the controller.

## To install the SmartPort connector

1. Install a ½" Female threaded "Tee" in the field wiring conduit (not included) approximately 12 inches below the X-Core.
2. Feed the red, white, and blue wires of the harness through the base of the "Tee" and into the wiring compartment as shown.
3. Screw the SmartPort harness

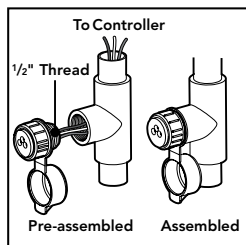

**NOTE:** P/N 258200 can be used as an alternate method to mount the SmartPort connector.

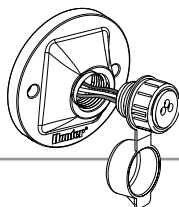

## POWER FAILURES

Due to the possibility of power failures, the controller has non-volatile memory. Programmed information will never be lost due to a power outage. The lithium battery will keep the correct time without AC power. Normal watering will resume when AC power is restored.

housing into the "Tee" as shown.

4. Attach the red, white, and blue SmartPort wires to the controller terminal as shown below:
  - Red wire to left side "24 VAC" terminal
  - White wire to right side "24 VAC" terminal
  - Blue wire to "REM" terminal

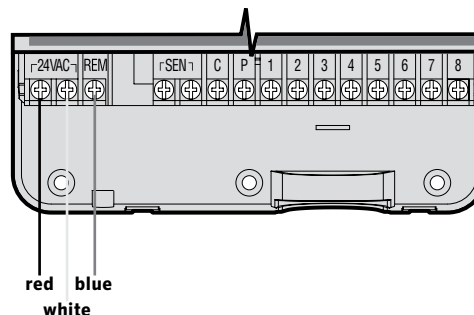



# PROGRAMMING THE CONTROLLER

The X-Core display shows the time and day when the controller is idle. The display changes when the dial is rotated to indicate the specific programming information to enter. When programming, the flashing portion of the display can be changed by pressing the **+** or **-** buttons. To change something that is not flashing, press the **◀** or **▶** buttons until the desired field is flashing.

Three programs A, B, and C, each with the ability to have four daily start times, permit plants with different watering requirements to be separated on different day schedules.

## Setting the Date and Time 🕒

1. Turn the dial to the **CURRENT TIME/DAY** position.
2. The current year will be flashing. Use the **+** or **-** buttons to change the year. After setting the year, press the **▶** button to proceed to setting the month.
3. The month and day will be in the display. The month will be flashing and the  icon will be displayed. Use the **+** or **-** buttons to change the month. Press the **▶** button to proceed to setting the day.
4. The day will be flashing and the  icon will be displayed. Use the **+** or **-** buttons to change the day. Press the **▶** button to proceed to setting the time.
5. The time will be displayed. Use the **+** and **-** buttons to select AM, PM, or 24 hour. Press the **▶** button to move to hours. Hours will be flashing. Use the **+** and **-** buttons to change the hour shown on the display. Press the **▶** button to move to minute. Minutes will be flashing. Use the **+** and **-** buttons to change the minutes shown on the display. The date, day, and time have now been set.



**NOTE:** A basic programming rule is that whatever symbol or character is flashing will be the item programmed. For instance, if the hour is flashing when setting the time, the hour can be changed or programmed. For illustration purposes in this manual, flashing characters are in GRAY type.

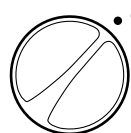

🕒 CURRENT TIME/DAY

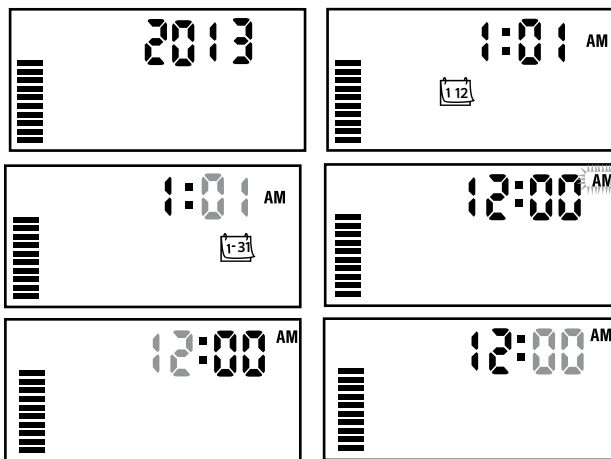

# PROGRAMMING THE CONTROLLER

## Setting the Program Start Time(s)

1. Turn the dial to the **START TIMES** position.
2. The factory preset is set on program A. If necessary, you can select program B, or C by pressing the **PROG** button.
3. Use the **+** or **-** button to change the start time. (The start times advance in 15 - minute increments).
4. Press the **▶** button to add an additional start time, or **PROG** button for the next program.

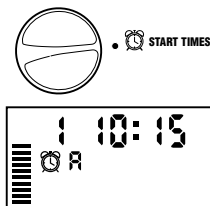

**NOTE:** One start time will activate all stations sequentially in that program. This eliminates the need to enter each station's start time. Multiple start times in a program can be used for separate morning, afternoon, or evening watering cycles. Start times may be entered in any order. The X-Core will automatically sort them.

## Eliminating a Program Start Time

With the dial set to **START TIMES** position, push the **+** or **-** button until you reach 12:00 AM (Midnight). From here, push the **-** button once to reach the OFF position.

Press the right arrow to eliminate a second start time.

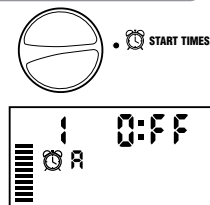

## Setting Station Run Times

1. Turn the dial to **RUN TIMES** position.
2. The display will show the last program selected (A, B, or C), the station number selected, **R** icon, and the station will be flashing. You can switch to another program by pressing the **PROG** button.
3. Use the **+** or **-** button to change the station run time on the display. You can set the run times from 0 to 4 hours.
4. Press the **▶** button to advance to the next station.

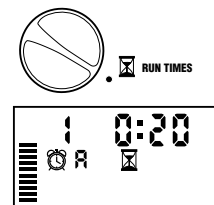

## Setting Days To Water

1. Turn the dial to the **WATER DAYS** position.
2. The display will show the last program selected (A, B, or C). You can switch to another program by pressing the **PROG** button.
3. The controller will display the seven days of the week (MO, TU, WE, TH, FR, SA, SU). Each day will have a **⬆** icon or a **⊗** icon above the day. The **⬆** icon would represent an "On" water day, while a **⊗** icon would represent an "Off" watering day.



## Selecting Specific Days of the Week to Water

1. With the **⬆** cursor on a specific day (the cursor will always start with MO), press the **+** button to activate a particular day of the week to water. Press the **-** button to cancel watering for that day. After pressing a button the cursor automatically advances to the next day.
2. Repeat step 1 until all desired days have been selected. The selected days will show a **⬆** to indicate their status is ON. The last **⬆** is the last day of watering for that program.

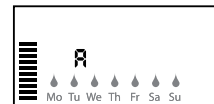

# PROGRAMMING THE CONTROLLER

## Selecting Odd or Even Days to Water

This feature uses numbered day(s) of the month for watering instead of specific days of the week (odd days: 1st, 3rd, 5th, etc.; even days: 2nd, 4th, 6th, etc.).

1. Press the ► right arrow until the cursor is over **SU**.

2. Press the right arrow one more time, and **Odd** will appear, with the [raindrop icon]. If **Odd** is desired, turn the dial back to the **Run** position.

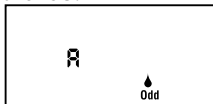

3. If even day watering is desired, press the [ ] button once. The [ ] icon and **EVEN** will be displayed. You can move back and forth from **ODD** to **EVEN** by pressing the [ ] buttons.



**NOTE:** The 31st of any month and February 29th are always "off" days if Odd watering is selected.

## Selecting Interval Watering

With this option you can select interval watering from 1 to 31 days.

1. With the cursor on **EVEN** or **ODD**, press the ► button once and the  icon will appear and a 1 flashing in the display. Interval watering schedule appears on the display.

2. Press the [ ] or [ ] button to select the number of days between watering days (from 1 to 31 days). This is called the interval.

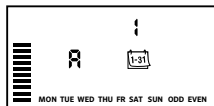

The controller will water the selected program at the next start time and will then water at the interval programmed.



**Note:** To exit Interval Mode (if it is not desired) press the left arrow button until the Day of Week display is shown again.

## Setting Event Day(s) Off

The X-Core allows you to program a No Water Day(s). This feature is useful to inhibit watering on specific day(s). For example, if you always mow the lawn on Saturdays, you would designate Saturday as a **No Water Day** so that you are not mowing wet grass.

1. Turn the dial to the **WATER DAYS** position.
2. Enter an interval watering schedule as described on page 19.
3. Press the ► button to scroll to the **No Water Days** at the bottom of the display. **MO** will be flashing.
4. Use the ► button until the cursor is at the day of the week you wish to set as a No Water Day.
5. Press the [ ] button to set this day as a no water day. The [ ] will illuminate over this day.
6. Repeat steps 4 and 5 until all desired event day(s) are off.



**NOTE:** You also have the option in the interval watering schedule to program Odd or Even days off.

## Automatic Watering

After programming the X-Core, set the dial to the **RUN** position to enable automatic execution of all selected watering programs and start times.

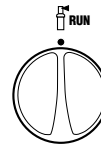

## System Off

Valves currently watering will be shut off after the dial is turned to the **SYSTEM OFF** position for two seconds. All active programs are discontinued and watering is stopped. To return the controller to normal automatic operation, simply return the dial to the **RUN** position.

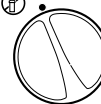

**SYSTEM OFF** 



# PROGRAMMING THE CONTROLLER

## Programmable Rain Off

This feature permits the user to stop all programmed waterings for a designated period from 1 to 7 days. At the end of the programmed rain off period, the controller will resume normal automatic operation.

1. Turn the dial to the **SYSTEM OFF** position. Wait for **OFF** to be displayed.
2. Press the **+** button as many times as needed to set the number of days off (up to 7 days).
3. Turn the dial back to the **RUN** position at which **OFF**, a number, the  and  icons will be displayed.

The days off remaining will decrease at midnight each day. When it goes to zero, the display will show normal time of day and normal irrigation will resume at the next scheduled start time.

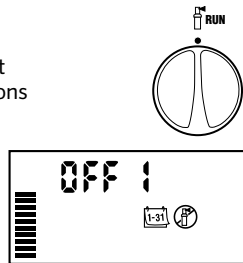
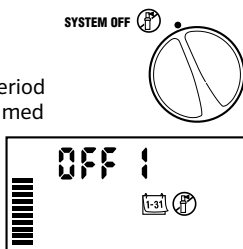

## Seasonal Adjustment %

Seasonal Adjustment is used to make global run time changes without reprogramming the entire controller. To use the Seasonal Adjustment feature:

1. Turn the dial to the **SEASONAL ADJUSTMENT** position.
2. The display will now show a flashing number followed by a %, as well as the bar graph which always remains on the display. Press the **+** or **-** button to



adjust the percentage of the seasonal adjustment. Each bar on the graph represents 10%. This feature can adjust the controller from 10% to 150% of the original program.

To view the adjusted run times, simply turn the dial to the **RUN TIMES** position, the displayed run time will be updated accordingly as the seasonal adjustment is made.



**NOTE:** The controller should always be initially programmed in the 100% position.

When using a Hunter “Clik” weather sensor, the Seasonal Adjustment value can be adjusted as described.

When using the Solar Sync ET sensor, the Seasonal Adjustment value is automatically updated daily based on the Solar Sync sensor. The Solar Sync ET sensor measures weather patterns, determines the optimal Seasonal Adjustment value, and then updates the controller on a daily basis. This value can be overridden manually by pressing the **+** or **-** buttons to the desired Seasonal Adjustment value. **However, it is important to understand that the manually adjusted Seasonal Adjustment value will be replaced at midnight by the new updated value from the Solar Sync sensor.**

To revert to a manually adjusted mode, the Solar Sync sensor must be uninstalled. See page 14 for instructions on how to uninstall the Solar Sync sensor.

## Manually Run a Single Station

# PROGRAMMING THE CONTROLLER

---

1. Turn dial to **MANUAL - ONE STATION** position.
2. Station run time will flash in the display. Use the ► button to move to the desired station. You may use the + or - button to select the amount of time for a station to water.
3. Turn the dial clockwise to the RUN position to run the station (only the designated station will water, then the controller will return to automatic mode with no change to the previously set program). Also see **One - Touch Manual Start and Advance**.

MANUAL-ONE STATION

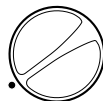

## One - Touch Manual Start and Advance

You can also activate all stations to water without using the dial.







1. Hold down the ► button for 2 seconds.
2. This feature automatically defaults to program A. You can select program B or C by pressing the PRG button.
3. The station number will be flashing. Press the ► button to scroll through the stations and use the + or - button to adjust station run times. (If no buttons are pressed for a few seconds during step 2 or 3, the controller will automatically begin watering).
4. Press the ► button scroll to the station you wish to begin with. After a 2 - second pause, the program will begin. At any time during the manual cycle, you can use the ◀ or ▶ buttons to navigate from station to station manually.



# ADVANCED FEATURES



## Programmable Sensor Override

The X-Core allows the user to program the controller so that the sensor disables watering on only desired stations. For example, patio gardens that have pots under overhangs and roofs may not receive water when it rains and will continue to need to be watered during periods of rain. To program sensor override:

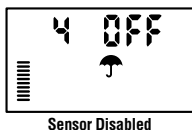
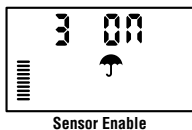
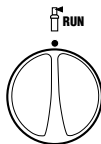
1. Turn the dial to the **RUN** position.
2. Press and hold the  button down while turning the dial to **START TIMES** position.
3. Release the  button. At this point, the display will show the station number, ON, and the  icon, will be flashing.
4. Press the  or  button to enable or disable the sensor for the station shown.  
ON = Sensor enabled  
(will suspend irrigation)  
OFF = Sensor disabled (will allow watering)
5. Use the  or  buttons to scroll to the next station that you would like to program the sensor override.





**NOTE: The controller default is for the sensor to disable watering on all zones when rain occurs.**

When the X-Core receives an input from the sensor to disable watering, the display will indicate those stations that have been programmed to override the sensor. A station that is running in the sensor override mode will flash the  and  icons alternately.





## Test Program of All Stations

The X-Core allows the user a simplified method for running a test program. This feature will operate each station in numerical sequence, from the lowest to the highest.

1. With the dial in the **RUN** position, press and hold the  button. The station number will be displayed and the time will be flashing for two seconds.
2. Use the  or  buttons to set the run time from 1 to 15 minutes. The run time needs to be entered only once.
3. After a - 2 second pause, the test program will start.

## Hunter Quick Check Diagnostics

This feature allows you to quickly diagnose wiring problems with your controller. Instead of having to check each field wiring circuit for potential problems, you can use the Hunter Quick Check circuit test procedure. To initiate the Quick Check test procedure:

1. Press the , , , and  buttons simultaneously. In the standby mode, the LCD will display all segments.
2. Press the  button once to begin the Quick Check procedure. Within seconds, the system searches all stations for detecting any circuit problems. When a field wiring short is detected, an ERR symbol preceded by the station number will momentarily flash on the display. After the Quick Check completes running the circuit diagnostic procedure, the controller returns to the automatic watering mode.

## ADVANCED FEATURES

### Easy Retrieve® Program Memory

The X-Core is capable of saving the preferred watering program into memory for retrieval at a later time. This feature allows for a quick way of resetting the controller to the original programmed watering schedule.

#### To save the program into the memory

1. With the dial in the **RUN** position, press and hold the **+** and **PRG** buttons for 5 seconds. The display will scroll three segments from left to right across the display indicating the program is being saved into memory.
2. Release the **+** and **PRG** buttons.

#### To retrieve a program that was previously saved into memory.

1. With the dial in the **RUN** position, press and hold the **-** and **PRG** buttons for 5 seconds. The display will scroll three segments from right to left across the display indicating the program is being saved into memory.
2. Release the **-** and **PRG** buttons.

### Programmable Delay Between Stations

This feature allows the user to insert a delay between stations when one station turns off and the next one turns on.

1. Start with the dial in the **RUN** position.
2. Press and hold the **-** button down while turning the dial to the **RUN TIMES** position.
3. Release the **-** button. At this point the display will show a delay time for all stations in seconds, which will be flashing.
4. Press the **+** or **-** buttons to increase or decrease the delay time between 0 seconds to 4 hours.
5. Return the dial to the **RUN** position.

### Resetting Controller / Clearing Controllers Memory

If you feel you have misprogrammed the controller, there is a process that will reset the memory to the factory defaults and erase all programs and data that have been entered into the controller.

1. Press and hold the **PRG** button.
2. While holding the **PRG** button, press and release button on the right - hand side of the controller.
3. Continue holding **PRG** button until time 12:00 am is displayed (this takes about 8 seconds).

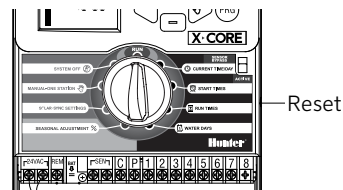

# CLIK DELAY INSTRUCTIONS

## Click Delay Feature

This feature allows the user to delay programmed waterings for a designated period (from 1-7 days) AFTER a Click Event ends. At the end of the Programmed Click Delay period, the controller will resume normal automatic irrigation.

1. Turn the dial to the **RUN** Position
2. Press and hold the **+** button for 3 seconds, then turn the dial to the **OFF** position
3. Release the **+** button. The display will show the programmable Click Delay.

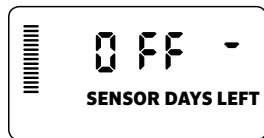
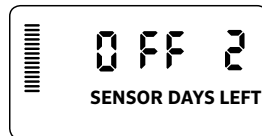

4. Press the **+** button to set Click Delay duration (from 1 to 7 days).
5. Return the dial to the **RUN** position. Click Delay is set.

After a Click Event ends (rain sensor changes from wet to dry) the Click Delay feature will become active and the screen will display Click Delay duration. The day countdown will occur 24 hours after the start of Click Delay.

An active Click Delay can be cancelled by turning the dial to the **OFF** position, waiting for OFF to stop flashing, then turning the dial back to the **RUN** position.

Any station that is set to override sensor, as well as Lighting Programs, will operate during a Click Delay event.



**NOTE:** Use caution when using the programmable Click Delay feature with Hunter Wind-Click®, Freeze-Click®, Soil-Click, and freeze component of Solar Sync and Rain/Freeze Click as the Click Delay will become active AFTER Click Event from these devices.

## HIDDEN FEATURES (CONTINUED)

### Cycle and Soak

The Cycle and Soak feature allows you to split a station's run time into more usable, shorter watering durations. This feature is useful when applying water to slopes and tight soils because it automatically applies water more slowly, helping to prevent runoff from occurring. You should enter the Cycle time as a fraction of the station's watering time, and the Soak time as the minimum number of minutes required before watering can occur again for the next Cycle. The total number of cycles is determined by taking the total programmed station run time and dividing it by the Cycle time.

#### Accessing the Cycle and Soak Menu:

The Cycle and Soak feature is accessed by placing the dial in the **RUN** position, pressing and holding the **+** button for 3 seconds; while holding the **+** button rotate the dial to the **RUN TIME** dial position, then release the button.

### Setting the Cycle Time:

Initially Station 1 will be displayed. To access other stations, press the **◀** or **▶** button.

Once the desired station is displayed, use the **+** or **-** button to increase or decrease the Cycle time. The user can set the time from 1 minute to 4 hours in 1 - minute increments or to **OFF** if no Cycle is desired.



**NOTE:** Before 1 hour, only minutes are displayed (e.g. 36). At 1 hour or above, the display will change to include the hour digit (e.g. 1:13 and 4:00).  
If a station's Run Time is less than or equal to the Cycle time, then no Cycle will be applied.

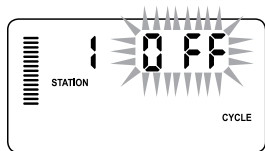

Example of Cycle screen upon entering

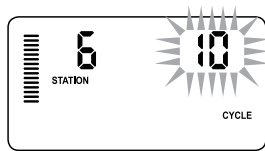

Example of Cycle screen with only minutes

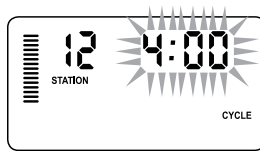

Example of Cycle screen with hours included

## HIDDEN FEATURES (CONTINUED)

### Accessing the Soak Menu:

Once the desired Cycle times for each station have been programmed, the Cycle time can be accessed by pressing the **PRG** button.

The station will remain the same as was previously displayed under the Cycle time (i.e. if station 2 is displayed in the Cycle menu then Station 2 will be displayed upon pressing the **PRG** button).



**NOTE:** The Soak menu cannot be accessed without a programmed Cycle time.

### Setting the Soak Time:

To access the other stations, press the ◀ or ▶ button.



**NOTE:** When changing the stations, if a station without a Cycle time is encountered, the screen will revert back to the Cycle time. Move to the next station with a Cycle Time and press the **PRG** button to return.

Once the desired station is displayed, the user can use the **+** or **-** button to increase or decrease the Soak time. The user can set the Soak time from 1 minute to 4 hours in 1 - minute increments.



**NOTE:** Before 1 hour, only minutes are displayed (e.g. 36). At 1 hour or above, the display will change to include the hour digit (e.g. 1:13 and 4:00).

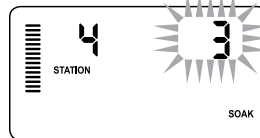

Example of Soak screen with only minutes

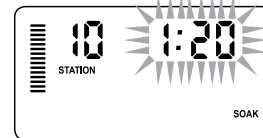

Example of Soak screen with hours included

### Cycle and Soak Situations:

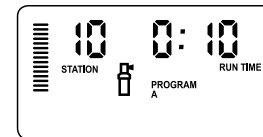

Station 1 requires 20 minutes of watering, but after 5 minutes, runoff occurs. However, after 10 minutes all the water is absorbed. The solution would be to program 20 minutes for the station run time, 5 minutes for the Cycle time, and 10 minutes for the Soak time.

The soak time is a minimum amount. The soak time may be longer amount depending on the remaining run times.



Station 10 cycle running

# TROUBLESHOOTING GUIDE

Problem	Causes	Solutions
The controller is continuously watering	Too many start times have been programmed	Only one start time is necessary to activate a program (refer to Setting the Program Start Times on page 18)
There is no display	Check AC power wiring	Correct any errors
The display reads “No AC”	There is no AC power present (the controller is not receiving any power)	Check to see if the transformer is properly installed
Display reads “Off,   ”	The rain sensor is interrupting irrigation or the sensor jumper has been removed	Slide the rain sensor bypass switch to the BYPASS position to bypass the rain sensor circuit, or reinstall the jumper
Rain sensor will not shut off the system	<ul style="list-style-type: none"> <li>• Defective rain sensor</li> <li>• Jumper was not removed when sensor was installed</li> <li>• Stations have been programmed to override the sensor</li> </ul>	<ul style="list-style-type: none"> <li>• Verify operation of rain sensor and proper wiring</li> <li>• Remove jumper from the sensor terminals</li> <li>• Reprogram the sensor override to enable the sensor (see page 11)</li> </ul>
Frozen display, or showing incorrect information	Power surge	Reset the controller per page 24 “Clearing Controller Memory/Resetting the Controller”
Display shows “ERR” with a number (1 to 8)	Short in the valve wiring circuit, or faulty solenoid on the station number indicated	Check wire circuit or solenoid for the valve number indicated. Repair short or replace solenoid. Press any button to clear the “ERR” from the display
Display shows “P ERR”	<ul style="list-style-type: none"> <li>• Faulty pump relay or master valve wiring</li> <li>• Incompatible or defective relay or solenoid</li> <li>• Undersized wire to the pump relay or master valve</li> </ul>	<ul style="list-style-type: none"> <li>• Check wiring to relay or master valve solenoid. Press any button to clear the “P ERR” from the display</li> <li>• Check electrical specification for the pump relay. Do not exceed controller’s electrical rating. Replace if defective</li> <li>• Replace wire with larger gauge wire</li> </ul>

# TROUBLESHOOTING GUIDE

Problem	Causes	Solutions
Display shows a station is running but the ☂ and ⏸ icons are flashing	The sensor is interrupting irrigation, however the station has been programmed to override the sensor	Check the sensor override status (see page 23)
Automatic irrigation does not start at the start time and controller is not in the System Off mode	<ul style="list-style-type: none"> <li>• AM/PM of time of day not set correctly</li> <li>• AM/PM of start time not set correctly</li> <li>• Start Time is disabled (set for Off)</li> <li>• Controller is not receiving AC power</li> </ul>	<ul style="list-style-type: none"> <li>• Correct AM/PM of time of day</li> <li>• Correct AM/PM of start time</li> <li>• See Setting Program Start Times (see page 18)</li> <li>• Check AC power connections</li> </ul>
The display shows dashes when the dial is in the Solar Sync Settings position	<ul style="list-style-type: none"> <li>• The Solar Sync sensor is not connected to the controller</li> <li>• The Solar Sync sensor wires may have a break in them or a bad connection</li> </ul>	Connect the Solar Sync to the “SEN” positions on the wiring terminal. The display will then show the Region and Water Adjustment setting.
Run times for a particular station are too short/too long when using a Solar Sync sensor	Program Run Time too long/short	Solar Sync provides a global seasonal adjustment to the controller. If a particular station has run times too long or too short, make the appropriate adjustment to the program in the controller. Make sure to change seasonal adjust back to 100% before making changes to program run times. Do this by turning the dial to the Seasonal Adjust position and increasing/decreasing the value to 100%.
Seasonal Adjust seems low	<ul style="list-style-type: none"> <li>• Region too high</li> <li>• Water Adjustment too low</li> <li>• Location of sensor does not allow for full sun</li> </ul>	Increase the value on the Water Adjustment scale (the default setting is 5). If you max out on the Water Adjustment scale at 10 and still require more seasonal adjustment, move down one Region (from 4 to 3, for example) and start at Water Adjustment setting 5. Solar Sync will immediately update the Seasonal Adjust on the controller. If it is still too high, repeat the adjustment until the desired seasonal adjust is showing on the controller.

## TROUBLESHOOTING GUIDE

---

<b>Problem</b>	<b>Causes</b>	<b>Solutions</b>
Seasonal Adjust seems high	<ul style="list-style-type: none"><li>• Region too low</li><li>• Water Adjustment setting too high</li></ul>	Decrease the value of the Water Adjustment setting. If you minimize the Water Adjustment scale at 1 and still require reduced seasonal adjustment, move up one Region (from 2 to 3, for example) and start at Water Adjustment setting 5. Solar Sync will immediately update the Seasonal Adjust on the Controller. If it is still too high, repeat the adjustment until the desired seasonal adjust is showing on the controller.
Solar Sync still sending Seasonal Adjust when Controller Bypass switch is in the “Bypass” position	Solar Sync’s automated Seasonal Adjustment cannot be deactivated by the Bypass switch. The Bypass switch only controls the Rain/Freeze shutoff function of the Solar Sync.	



# SPECIFICATIONS

---

## Operating Specifications

- Station Run Times: 0 to 4 hours in 1-minute increments
- 3 Independent Watering Programs
- Start Times: 4 per day per program for up to 12 daily starts
- Watering Schedule: 365-day calendar, interval watering, odd/even watering
- AM/PM, 24-hour clock
- Simple manual operation
- Sensor override by station
- Programmable rain delay (1 to 7 days)
- Manual Seasonal Adjustment (10% to 150%)
- Automatic Seasonal Adjustment using Solar Sync sensor
- Sensor bypass switch
- X-Core-x00i for indoor use. X-Core-x00 for outdoor use
- Sea level to 6500 ft (2000 m) at -13° F to 140° F (-25° C to 60° C)

## Dimensions

### Indoor Cabinet

- Height: 6.5" (16.5 cm)
- Width: 5.75" (14.6 cm)
- Depth: 2" (5 cm)

### Outdoor Cabinet

- Height: 8.625" (22 cm)
- Width: 7" (17.8 cm)
- Depth: 3.75" (9.5 cm)

## Electrical Specifications

- Transformer input 120 VAC  $\pm 10\%$  60 Hz (230 VAC  $\pm 10\%$  50/60 Hz International Models)
- Transformer Output: 24 VAC 1.0 amp
- Station Output: 0.56 amps per station
- Maximum Output: 0.90 amps (includes master valve)
- Battery: 3 V Lithium (included) used for remote programming and backup timekeeping. Use CR2032 3-volt.
- Electronic short circuit protection
- Non-volatile memory for program data
- UL Listed
- Model X-Core-x00 has an IP2X Rating
- Clean only with a cloth dampened with mild soap and water

## Explanation of Symbols

~ = AC

 = Consult Documentation

 = Hazardous Voltages Present

 = Ground

# CERTIFICATE OF CONFORMITY TO EUROPEAN DIRECTIVES

---

Hunter Industries declares that the irrigation controller Model X-Core complies with the standards of the European Directives of “electromagnetic compatibility” 87/336/EEC and “low voltage” 73/23/EEC.

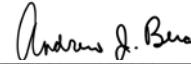

Senior Regulatory Compliance Engineer

This product should not be used for anything other than what is described in this document. This product should only be serviced by trained and authorized personnel.

## **FCC part 15:**

This equipment has been tested and found to comply with the limits for a Class B digital device, pursuant to part 15 of the FCC Rules. These limits are designed to provide reasonable protection against harmful interference in a residential installation. This equipment generates, uses and can radiate radio frequency energy and, if not installed and used in accordance with the instructions, may cause harmful interference to radio communications. However, there is no guarantee that interference will not occur in a particular installation. If this equipment does cause harmful interference to radio or television reception, which can be determined by turning the equipment off and on, the user is encouraged to try to correct the interference by one or more of the following measures:

- Reorient or relocate the receiving antenna
- Increase the separation between the equipment and receiver
- Connect the equipment into an outlet on a circuit different from that to which the receiver is connected
- Consult the dealer or an experienced radio/TV technician for help



**Hunter**<sup>®</sup>

---

**Hunter Industries Incorporated**

1940 Diamond Street • San Marcos, California 92078 USA  
[www.hunterindustries.com](http://www.hunterindustries.com)

© 2017 Hunter Industries Incorporated

LIT-397-EN G 11/17